

Bench-Top Meters

860031, 860032 and 860033

Instruction Manual

TABLE OF CONTENTS

INTRODUCTION.....	4
FEATURES.....	4
POWER SUPPLY	5
METER COMPONENTS	5
LCD DISPLAY	8
KEYPAD	9
REAR PANEL	10
SETUP MODE.....	11-22
Memory Transmission	11
Clear Memory.....	12
View Slope & Offset (pH Probe).....	13
Calibration Review (Conductivity Probe).....	15
pH Calibration Buffer (pH Probe)	16
Select Buffer	16
Cell Constant (Conductivity Probe)	17
Temperature Setting (Conductivity Probe)	18
Ready Icon	20
Temperature Units	20
Real Time Clock Setting	21
Reset.....	22
PH PROBE CALIBRATION	23
CONDUCTIVITY PROBE CALIBRATION	25
TDS CALIBRATION.....	28
SALINITY CALIBRATION.....	28

MEASUREMENT PROCEDURES	29-38
Preparing for Measurement	29
Hold Function	29
pH Measurement.....	30
mV Measurement (± 499 mV)	31
ORP (mV) Measurement (± 1999 mV).....	32
Conductivity Measurement.....	32
Total Dissolved Solid Measurement	33
Salinity Measurement.....	34
Automatic Temperature Compensation.....	35
Manual Temperature Compensation	35
Auto and Manual Range	36
Record Memory.....	37
Recall Memory	37
Recall Maximum & Minimum.....	38
MAINTENANCE	39
TROUBLESHOOTING	42
ERROR CODES.....	43
PC CONNECTION	44
APPENDICES	47
OPTIONAL ACCESSORIES.....	51
SPECIFICATIONS.....	52
WARRANTY	56

Bench-Top Meters 860031, 860032, 860033

Copyright ©2016 by Sper Scientific

ALL RIGHTS RESERVED

The contents of this manual may not be reproduced or transmitted in any form or by any means electronic, mechanical, or other means that do not yet exist or may be developed, including photocopying, recording, or any information storage and retrieval system without the express permission from Sper Scientific.

INTRODUCTION

Sper Scientific is pleased to offer the following line of bench-top meters:

Model 860031 (pH/mV)

Model 860032 (Conductivity/TDS/Salinity)

Model 860033 (Water Quality)

Please note that the meter itself is identical in each of the above models. Each model can be used for pH/mV, Conductivity/TDS/Salinity or Water Quality depending on the probe used.

To utilize your meter under additional parameters, please refer to the list of probes in OPTIONAL ACCESSORIES on page 51.

Instructions for all three models are contained within this manual. Refer to the TABLE OF CONTENTS for the subsection within MEASUREMENT PROCEDURES that corresponds to the particular parameter you are measuring.

FEATURES

- Multi-display LCD screen
- N.I.S.T. buffer recognition
- Hold function
- Maximum and minimum
- Reliable, replaceable probe with temperature compensation
- Easy to view probe calibration data
- “Ready” icon on LCD display indicates stability for reading
- PC connection for online logging and uploading 99 memories for analysis
- Automatic or manual temperature compensation
- Analog output for chart recorders

POWER SUPPLY

The meter is powered by a 9 Volt DC adaptor (included). The plug of the adaptor is USA type; you will need to purchase a plug converter if using the meter outside of the US.

Plug the adaptor into the power port labeled “DC,” located on the rear of the meter.

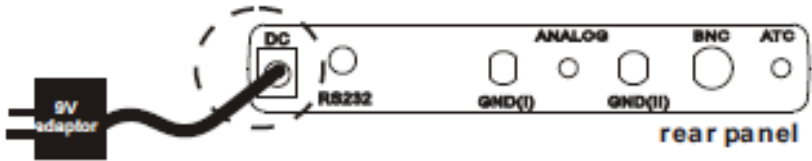

METER COMPONENTS

Meter Drawer

A built-in drawer is located on the bottom of the bench-top meter. Pull the drawer out and use to store notes and other important reference data.

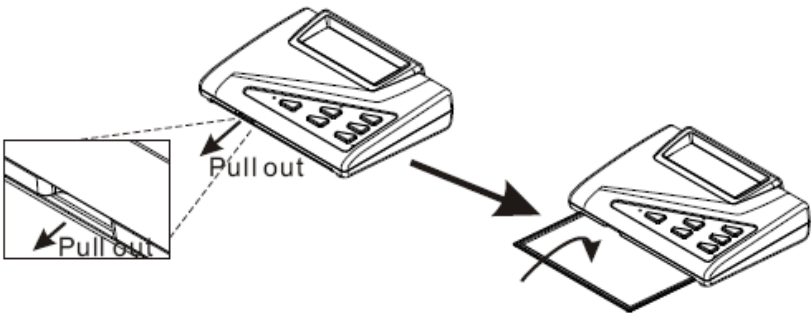

METER COMPONENTS

Probe Holder

The probe holder is composed of two parts: the base and arm. Holder assembly does not require tools. The maximum swing angle is 70° and the maximum height of the holder is 378 mm.

Holder Assembly

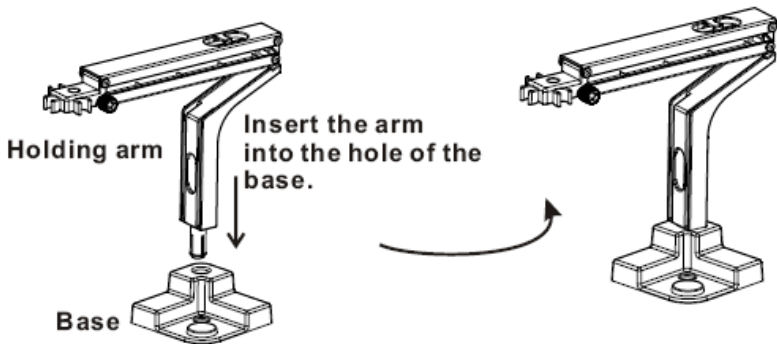

Holder Disassembly

To disassemble the holder from the base:

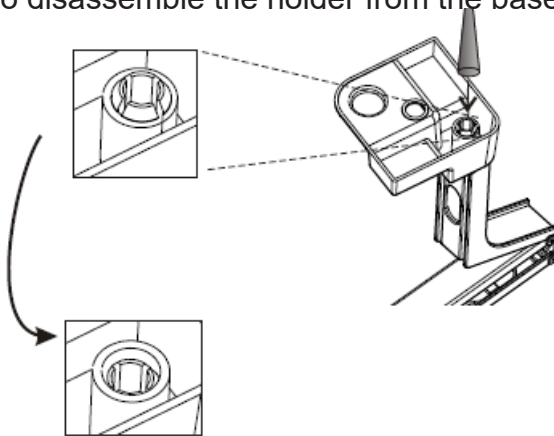

1. Turn the base upside down.
2. Use a cylindrical object with an approximate 12 mm diameter to push the arm out of the base.

METER COMPONENTS

Attaching Holder to the Meter

After assembling the holder, attach the holder to the meter.

1. Find the two holes on the bottom of the meter that are used to hold the base.
2. The holder can be attached to the right or left side of the meter

Locate the two holes at the bottom of the meter.

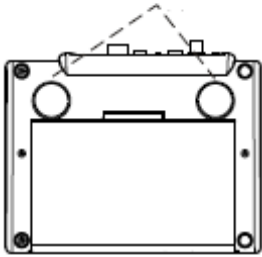

The cylindrical knob on the holder base is designed to fit into the hole on the bottom of the meter.

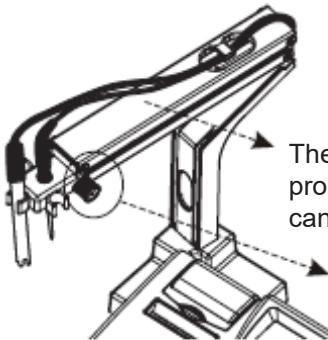
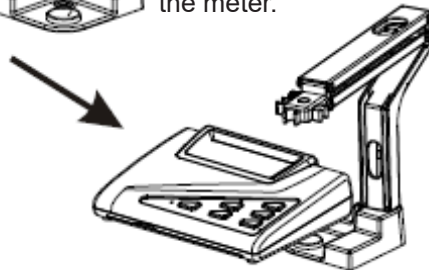
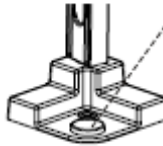

The holder can hold up to 4 probes. The wire of the probe can be fixed to the arm.

Turn clockwise to lock the holder into place. Turn counterclockwise to adjust the holder up and down.

LCD DISPLAY



Primary Data Screen displays pH, mV, ORP, Conductivity, TDS or Salinity value.

Icons **CON**, **TDS**, **SALT**, **ORP**, **pH**, **mV** indicate the parameter displayed.

Icons **ppt**, **ppm**, **mg/l**, **mS**, **μS**, **kPA**, or **mmHg** indicate the unit of measure displayed.

READY indicates the reading is stable.

AUTO indicates auto-ranging function.

MAX, **MIN** indicate a maximum or minimum memory value.

HLD Holds the current reading on the display.

REC indicates the meter is in recall mode.

MEM indicates the current measured value is saved.

The digital number under MEM indicates the total number of saved records.

The **88-88-88** are real time **Y-M-D** (Year-Month-Date) or **H:M:S** (Hour-Minute-Second).

ATC indicates the meter is in Automatic Temperature Compensation Mode.

The temperature display is indicated at the bottom of the LCD. Temperature unit °C or °F is selectable.

KEYPAD

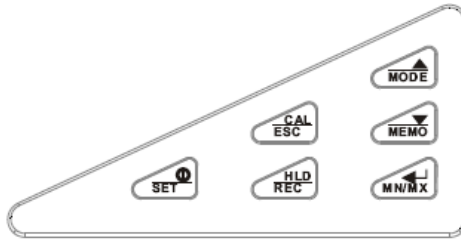

POWER/SET

Press to turn the meter **on/off**. Press and hold for more than 1 second to enter **SET** Mode. The meter will default to the last mode used when turned **off** and back **on**.



CAL/ESC

Switch between **NORMAL** and **CALIBRATION** Mode. Press to enter manual temperature setting. In Calibration, Setting or Recall Modes, press to return to Normal Mode.



HLD/REC

Press to freeze the reading. Press again to release. Press for more than 1 second to switch between **NORMAL** and **RECALL** Modes.



MODE/▲

Press to switch the mode.
Press to increase the setting value.



MEMO/▼

Press to save the current reading.
Press to decrease the setting value.



MN/MX/ CONFIRM

Press to confirm calibration or parameter setting. Press to view the min/max of the memory in Recall Mode. Press to select **AUTO** or **Manual** ranging when in Cond./TDS/SALT.

REAR PANEL

The bench-top meter provides a complete set of input connectors for various commonly-used accessories:

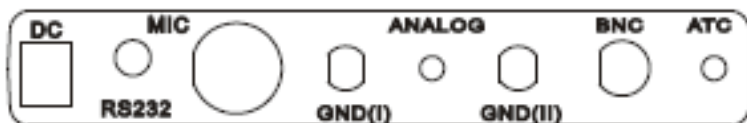

Connection	Function
DC	Connection of the AC to DC adaptor power supply
RS232	Connection of a RS232 or USB cable to a computer to capture online or stored data
MIC	Conductivity probe input
GND (I)	Earth ground jack inputs (standard tip connectors)
GND (II)	Earth ground jack inputs (standard tip connectors)
ANALOG	Strip chart recorders input. Use subminiature plug with positive tip.
BNC	The port accepts pH, ORP with a BNC connector. Ensure that the connector is clean and dry before connecting.
ATC	Phone jack input for the temperature probe for automatic temperature compensation

SETUP MODE

The advanced Setup Mode allows you to customize the following meter preferences and defaults:

- Memory Transmission
- Clear Memory
- Slope and Offset (pH) or Calibration Review (Conductivity)
- Buffer Solution (pH) or Cell Constant (Conductivity)
- Temperature Setting (pH)
- Ready Function
- Temperature Units
- Real Time Clock
- Reset

To enter Setup Mode, press **SET** for more than 2 seconds while the meter is in Normal Mode.

Note...

To exit Setup Mode without saving, press **ESC** until Normal Mode appears. If the meter is in Setup Mode, press **ESC** twice to exit. For Conductivity, pH, and mV default settings, refer to pages 54-55.

Memory Transmission

To transfer stored data from the meter to the computer:

1. Connect a RS232 or USB cable to the rear of the meter, then connect the other end of the cable with the D-sub connector to the computer's serial port. Run the software associated with this feature.
2. Press **SET** for 2 seconds to enter setup. "TR" appears on the middle of the LCD display and P1.0 appears under "TR."



SETUP MODE

3. Press . "OUT" flashes on the upper display and P1.1 appears under "OUT." This indicates that memories are transferring. After transmission, the LCD will return to P1.0.



Note..

The meter can store up to 99 records for each parameter. If you want to transmit data for a different parameter, press **MODE** to select your parameter before entering setup.

Clear Memory

1. Press **MODE** to select the parameter you want cleared before entering Setup Mode.
2. Press **SET** for 2 seconds to enter setup. Press  to select the memory clear function.
3. "CLR" appears on the middle display with P2.0 in the lower display.



4. Press  to enter step P2.1. The default "NO" icon flashes on the middle display and P2.1 appears in the lower display.

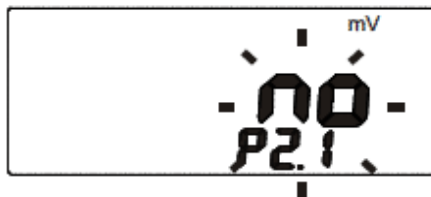

SETUP MODE

5. Press ▲ to change the status from “NO” on the display to “YES” and then press ↩ again to confirm clear memory. The LCD will return to P2.0 when all memories are deleted.

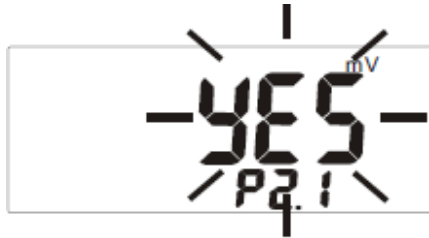

CAUTION:

THE MEMORY CLEAR PROGRAM IS DESIGNED TO CLEAR 99 MEMORIES AT ONE TIME. PLEASE CAREFULLY CONSIDER IF YOU WANT TO CLEAR THE MEMORY AS THIS OPERATION CANNOT BE REVERSED.

View Slope & Offset (pH Probe)

1. Press **MODE** to select the probe type as pH.
2. Press **SET** for 2 seconds to enter setup.
3. Press ▲ until “ELE” appears in the middle display and P3.0 appears in the lower display.



SETUP MODE

4. Press  to enter P3.1, the LCD displays one of four available slope values; P3.1, P3.2, P3.3, P3.4. If the value is less than 75% or more than 115%, change the probe immediately.

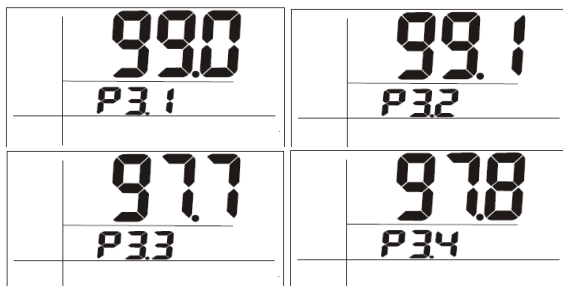

5. Press  to enter P3.2, P3.3, and P3.4.

Note...

The solution range differs between NIST and Custom buffers.

	P3.1	P3.2	P3.3	P3.4
NIST	0.00~4.01	4.01~6.86	6.86~9.18	9.18~14.00
CUST	0.00~4.50	4.50~7.00	7.00~9.50	9.50~14.00

6. Press  to enter P3.5 and view the offset value. The offset value is the mV value of pH 7 (default 0.0). The offset value will be different after calibration. If the value is outside the range of ± 60 mV, replace the probe.



SETUP MODE

Calibration Review (Conductivity Probe)

This feature allows you to review which range has been calibrated and the last calibration value. The program reviews the probe calibration data of Conductivity, TDS or SALT.

Note...

If the range is not yet calibrated, the LCD will display the default value. There are 5 total calibration ranges for Conductivity, TDS and SALT.

Range 1 to 3: Conductivity or TDS value

Range 4 to 5: Conductivity, TDS or SALT value

1. Press **MODE** to select the probe program.
2. Press **SET** for 2 seconds to enter setup.
3. Press **▲** to select CAL. "CAL" appears on the middle of the LCD and P3.0 appears on the lower portion.



4. Press **←** to enter P3.1. Press **←** to enter P3.2, P3.3, P3.4, P3.5.
5. Press **ESC** to return to P3.0.
6. Press **ESC** to return to Normal Mode.

The default values are:

Range1	Range2	Range3	Range4	Range5
14.13uS	141.3uS	1413uS	14.13mS	141.3mS

SETUP MODE

pH Calibration Buffer (pH Probe)

This meter allows the selection of two different types of pH buffers: **NIST** or **CUSTOM**. Selection of the proper buffer more accurately calibrates the probe to specific requirements.

NIST buffer: List of N.I.S.T. buffer recognition points.

pH 1.68, 4.01, 6.86, 9.18, 12.45

CUSTOM buffer:

pH 1.00 to 3.00, 3.50 to 5.50, 6.00 to 8.00, 8.50 to 10.50, 11.50 to 13.50

Select Buffer

1. Press **SET** for 2 seconds to enter setup.
2. Press **▲** to select pH buffer. "BUF" appears on the middle of the LCD and P4.0 appears on the lower portion.



3. Press **◀** to enter P4.1. The default "CUST" will flash on the LCD and P4.1 will appear on the lower portion of the display. If you use CUST buffers, press **◀** to confirm and the meter returns to P4.0.

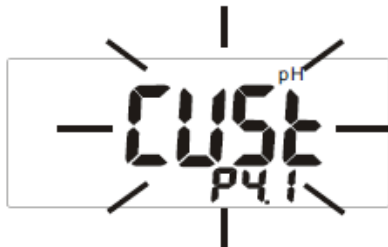

4. If your requirement is not for CUST buffers, press **▲** to change the status to NIST buffer.

SETUP MODE

5. Press  to confirm and the meter will return to P4.0.

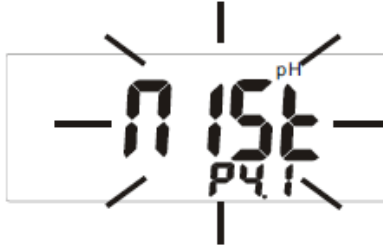

6. Press **ESC** to return to Normal Mode.

Cell Constant (Conductivity Probe)

To view the probe data (cell constant) of each range:

Note...

If the range is not yet calibrated, the LCD will display the default value (1.000).

1. Press **MODE** to select the probe program.
2. Press **SET** for 2 seconds to enter setup.
3. Press **▲** to select CELL. "CELL" will appear on the middle of the LCD and P4.0 will appear on the lower portion.



4. Press  to enter P4.1. Press  to enter P4.2, P4.3, P4.4, P4.5.



Note...

Cell constant may degrade with time and usage.

SETUP MODE

Temperature Setting (Conductivity Probe)

Use this program to set the temperature parameters and TDS conversion factors.

Parameters	Range	Default
P5.1 ATC/MTC	AUTO or NAn (Non-Auto)	AUTO
P5.2 Tc (Temp. Coefficient)	0.0%/C to 10.0%/C	2.1%/C
P5.3 Manual temp. Calibration	0.0 to 80.0 degree C	25.0 degree C
P5.4 TDS conversion factor	0.300 to 1.000	0.500

1. Press **MODE** to select the probe program.
2. Press **SET** for 2 seconds to enter setup.
3. Press **▲** to select COEF. "COEF" will appear on the middle of the LCD and P5.0 will appear on the lower portion.



4. Press **◀** to enter P5.1. The default "Auto" flashes on the middle of the LCD and P5.1 will appear on the lower portion. To switch to manual temperature compensation mode, press **▲** to change the status, then press **◀** to confirm and enter P5.2.



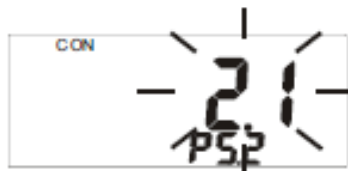

5. The default "2.1" flashes on the middle of the LCD and P5.2 will appear on the lower portion.
6. To adjust the temperature coefficient from 2.1, press **▲** or **▼**. Press **◀** to confirm and enter P5.3.



SETUP MODE

Note...

When using Manual Temperature Compensation Mode (MTC), you must set the temperature solution in P5.3.



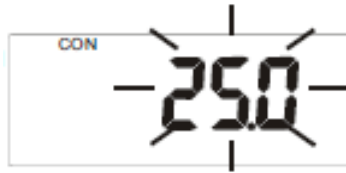

7. At P5.1, press  twice to enter P5.3. The default “25.0” flashes on the middle of the LCD and P5.3 will appear on the lower portion. To adjust the solution temperature setting, press  or .



8. Press  to confirm and enter P5.4.

Note...

When using the TDS measurement mode, you must set the TDS conversion factor in P5.4.

9. At P5.1, press  three times to enter P5.4. The default “0.500” flashes on the middle of the LCD and P5.4 will appear on the lower portion. If the TDS conversion factor of the solution is not 0.5, press  or  to adjust the value. Press  to confirm and return to P5.0.



SETUP MODE

Ready Icon

This feature enables/disables the “READY” icon, which indicates that the measured reading is stable.

1. Press **SET** for 2 seconds to enter setup.
2. Press **▲** to select “READY” on the display. P6.0 will appear on the lower display.



3. Press **←** to enter P6.1. “YES” will flash on the LCD display and P6.1 will appear on the lower display.



4. Press **▲** to switch between YES or NO.
5. Press **←** to confirm and return to P6.0.
6. Press **ESC** to return to Normal Mode.



Temperature Units

To select either Celsius or Fahrenheit temperature scale:

1. Press **SET** for 2 seconds to enter setup.
2. Press **▲** to select “unit” on the upper display. P7.0 will appear in the lower portion of the display.



SETUP MODE

3. Press  to enter P7.1. The last selected unit “C” or “F” will appear on the LCD.
4. Press  to select either display.

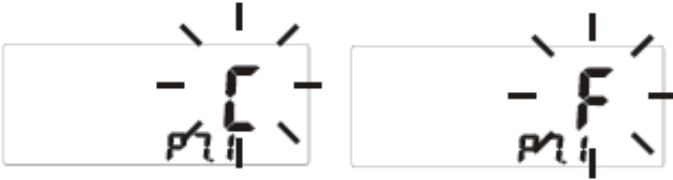

5. Press  to save the selection and return to P7.0.
6. Press **ESC** to return to Normal Mode.

Real Time Clock Setting

This procedure adjusts the meter’s internal clock. An internal battery powers the real time clock independent of the meter’s power source.

1. Press **SET** for 2 seconds to enter setup.
2. Press  to select “rtc” on the LCD display. P8.0 appears on the lower display.



3. Press  to enter P8.1. The year flashes in the lower left corner of the LCD display. (The year is the last two digits only; for example, 1999 would be 99).

Symbol:	Y-M-D	H:M:S
Definition:	Yr.-Mo.-Day	Hr.-Min.-Sec.
Range:	99-12-31	23-59-59

4. Press  to step through the following “P’s.” All are **two digits**.

P8.1 = Year	P8.2 = Month	P8.3 = Day
P8.4 = Hour	P8.5 = Minute	P8.6 = Seconds

SETUP MODE

5. Press ▲ and ▼ to adjust values up or down, respectively.
6. Press **ESC** to return to P8.0.
7. Press **ESC** to return to Normal Mode.

Reset

This procedure will reset the meter to factory default settings. Memory locations are not reset after this procedure.

1. Press **MODE** continuously until you reach the mode that you want to reset. When resetting pH/mV, only pH and mV will revert to the default values. The COND/TDS/SALT parameters will not be reset unless you select the mode as COND/TDS/SALT. Refer to pages 54-55 for default values of each parameter.
2. Press **SET** for 2 seconds to enter setup.
3. Press ▲ to select the reset section of the meter.



4. "rSt" will appear on the LCD and P9.0 will appear directly below.

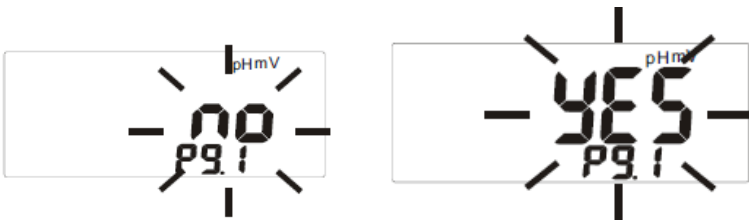

5. Press ◀ to enter P9.1.
6. Press ▲ to switch between "YES" or "NO."
7. Press ◀ to confirm and return to P9.0.
8. Press **ESC** to return to Normal Mode.

PH PROBE CALIBRATION

Calibration is necessary before measurement. Make certain that the buffer value is close to that of the sample being measured and that the buffer temperature remains stable.

1. Press **POWER** to turn the meter on and press **MODE** continuously to select pH.
2. Rinse the probe in de-ionized water or rinse solution. Shake and air dry but **DO NOT** wipe the pH probe dry. Wiping the probe may cause static and cause calibration and measurement instability.
3. Select the pH buffer and pour solution (a sufficient amount to totally immerse the probe tip) into a clean container.
4. Dip the probe into the container, immersing the probe tip.
5. Stir the probe gently to create a uniform sample.
6. Press **CAL** to enter calibration mode. "CAL" will flash on the lower left of the LCD.

Note...



The main display indicates the measured value, and the secondary display value indicates the desired value according to the buffer type selected (NIST or CUSTOM). Refer to CALIBRATION BUFFER page 16.

7. If NIST is selected, the lower display indicates the value of the solution at the current temperature.

Note...

If this secondary value continues to fluctuate, check the buffer or probe. (Refer to TROUBLESHOOTING page 42). If CUST is selected, the lower middle display indicates the default, 2.00. Press **HLD** to select the buffer range needed. Press **▲** or **▼** to adjust the lower middle display to coincide with the main display reading.

8. When the measured pH value is stable and the Ready function is enabled (Refer to P6.0 READY ICON page 20), "READY" will appear on the left side of the LCD. Press to confirm.
9. - For 1-Point Calibration, proceed to Step 10.
- For 2-Point, 3-Point and Multiple-Point Calibration, Repeat Steps 2 through 8 for each buffer.
10. Press **ESC**.

Note...

For 2-Point, 3-Point and Multiple-Point Calibration, do not press **ESC** until after the final buffer has been calibrated.

CONDUCTIVITY PROBE CALIBRATION

Selecting Calibration Standard Solution

For best results, select a conductivity, TDS or NaCl standard near the sample value that you are measuring. Alternatively, use a calibration solution value that is approximately 2/3 of the full scale of the measurement range that you plan to utilize.

For example, in the 0 to 1999 uS range, use 1413 uS solution for calibration.

DO NOT reuse the calibration solution. Contaminants in the solution will affect the calibration and the accuracy. Use fresh solution each time.

Refer to the table below. For best results, use the recommended solution for various conductivity and TDS ranges.

Conductivity Measuring Range		Recommended Cal. Solution Range	TDS Measuring Range (factor=0.5)		Recommended Cal. Solution Range
1	0 to 19.99 uS	6.00 to 17.00 uS	1	0.00 to 9.99 ppm	3.00 to 8.50 ppm
2	0 to 199.9 uS	60.0 to 170.0 uS	2	0.0 to 99.9 ppm	30.0 to 85.0 ppm
3	0 to 1999 uS	600 to 1700 uS	3	0 to 999 ppm	300 to 850 ppm
4	0 to 19.99 mS	6.00 to 17.00 mS	4	0.00 to 9.99 ppt	3.0 to 8.50 ppt
5	0 to 199.9 mS	60.0 to 170.0 mS	5	0.0 to 199.9 ppt	30.0 to 85.0 ppt

The previous calibration data will be replaced after re-calibrating. For example, if you previously calibrated the conductivity meter at 1413 uS in the 0 to 1999 uS range, when you re-calibrate at 1500 uS again (also in the 0 to 1999 range), the previous 1413 uS calibration point will be replaced in this range (0 to 1999 uS). However, the meter will retain the calibration data for other ranges that have not yet been calibrated.

Note...

The temperature coefficient of the meter defaults to 2.1% per °C and provides good results for most applications. To reset the coefficient, see P5.2 on page 18.

CONDUCTIVITY PROBE CALIBRATION

Selecting Calibration Schedule

For first use and best results, use solution to calibrate.

If the conductivity of the measured solution is $< 100 \mu\text{S}$ or the TDS is $< 50 \text{ ppm}$, calibrate the meter weekly to achieve the specified accuracy.

If the meter is used in the mid ranges, calibrate the unit monthly.

If the measurement is performed at extreme temperatures, calibrate the unit weekly.

To Calibrate:

1. Insert the probe into deionized or distilled water for about 30 minutes to rinse the probe.
2. Select the conductivity standard for calibration. (Refer to page 25.)
3. Pour 4 cm (deep) of buffer solution into two separate containers (A & B).
4. Rinse the probe in one of the containers. Gently stir the probe.
5. Dip the rinsed probe into the other container. Tap the probe on the bottom of the container to remove air bubbles. Let the probe stabilize to the solution temperature.

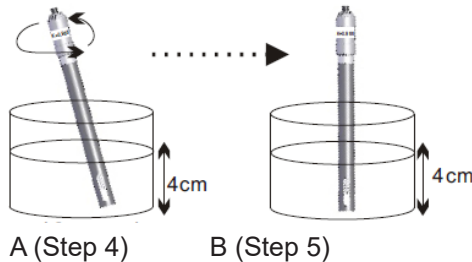

6. Turn the meter **on**. In Normal Mode, press **MODE** continuously to select the mode as CON.
7. Press **CAL** to enter Calibration Mode. The probe automatically detects the conductivity value of the solution. The value will flash on the LCD.
8. Wait for the measured conductivity value to stabilize. If you have enabled the Ready function in P6.0, the ready icon will appear on the upper left corner of the LCD when the calibration is stable.

CONDUCTIVITY PROBE CALIBRATION

9. Press ▲ or ▼ to adjust the value on the primary display to match the value of the standard buffer. There are two options:

- To input the value based on current temperature, the Temperature Coefficient (page 18) must be 0.0.
- To input the value based on 25°C, refer to APPENDIX C on page 48 to select the temperature coefficient value.

Note...

You can adjust the conductivity reading $\pm 20\%$ from the measured value. If the detected value and the standard value differ by more than $\pm 20\%$, clean or replace the probe.

Example:

Standard: 10 μ S; Detected value: 19 μ S

Adjustable range: $\pm 3.8 \mu$ S ($19 \times 20\%$)

However, under the above situation, the values already differed over 20%.

Note...

When the calibration is stable, "READY" will appear on the LCD. If "READY" does not appear, check that the calibration solutions and input value (Step 9, page 27) are correct and that the ready icon is enabled (page 20).

If the standard value is over the measuring range or 10% less, the displayed value will be equal to the range limit or 10% of the range limit. Under this condition, go to the parameter setting first to manually select a suitable range (see page 36).

Example 1:

Standard: 22 μ S; Detected value: 19 μ S

Adjustable range: $\pm 3.8 \mu$ S ($19 \times 20\%$)

Although the values differ less than 20%, the 22 μ S is still over the range limit (because the maximum input value is 19.99 μ S). In this instance, you must manually select the range as 0 to 199.9 μ S and then adjust the value to 22 μ S.

Example 2:

Standard: 1.6 μ S; Detected value: 2.1 μ S

Adjustable range: $\pm 0.42 \mu$ S ($2.1 \times 20\%$)

Although the measured value differs less than 20%, the 1.6 μ S is still less than the 10% range limit ($19.99 \times 10\%$). Therefore, the maximum input value is 2.00 μ S.

TDS CALIBRATION

There are two options for TDS calibration:

Option 1: Using TDS Standards

The procedure for TDS calibration is almost the same as the procedure for conductivity calibration. Differences are as follows:

1. Select the TDS standard for calibration. The default TDS conversion factor is 0.50. If your solution has a different TDS factor, you can improve the calibration accuracy by setting the TDS factor before starting the calibration. To set the TDS factor for the correct value, refer to the value provided by the standard solution manufacturer or see Appendix A (page 47).
2. In Measurement Mode, press **MODE** to select TDS and press **CAL** to enter Calibration Mode.

Option 2: Using Conversion Factors

TDS values are related to conductivity. You can calibrate the meter by using the conductivity standards above and then program the meter with a given conversion factor.

1. Perform the conductivity calibration procedure (page 25).
2. Select the correct conductivity-to-TDS conversion factor. Refer to Appendix A (page 47) or calculate the TDS conversion factor for other solutions using the formula shown in Appendix B (page 61).
3. Refer to P5.4 (page 19) for the procedure to set the TDS conversion factor.

SALINITY CALIBRATION

The procedure for salinity calibration is almost the same as the procedure for conductivity calibration. Differences are as follows:

1. In Measurement Mode, press **MODE** to select the mode as SALT and press **CAL** to enter Calibration Mode.
2. There are two measuring ranges for salinity: 0 to 11.38 ppt and 0 to 80.0 ppt. Please select a NaCl standard that is near the sample value you are measuring.

MEASUREMENT PROCEDURES

Preparing for Measurement

1. Assemble the probe holder and attach the holder to the meter (pages 6-7).
2. Connect an adaptor to the power jack. Slide the adaptor jack into the meter, making sure it is firmly in place. (The meter's voltage is 9V.)
3. For pH and ORP measurements, connect a sensor probe to the BNC port. For conductivity, TDS and salinity measurements, connect a sensor probe to the MIC port.
4. For a pH probe with a temperature sensor, connect a temperature sensor connector to the ATC port.
5. Connect a USB or RS232 cable to the meter and your computer to upload real time measurement values and memories for further analysis (page 44).
6. Connect your chart recorder or other data collection devices to the ANALOG port as needed.

Available measurement parameters for each probe type:

	pH	mV/ORP	Cond.	TDS	Salinity
pH Probe	✓	✓			
Cond. Probe			✓	✓	✓
ORP Probe		✓			

IMPORTANT: The temperature of the measured liquid must be stable. pH and conductivity probes CANNOT be placed in the same container while taking measurements.

Hold Function

This function allows you to freeze current readings on the display in Normal Mode.

1. Press **POWER** to turn the meter **on**.
2. Press **HLD** while in Normal Mode. "HOLD" appears on the display.
3. To release the Hold function, press **HLD** again.

MEASUREMENT PROCEDURES

pH Measurement

pH measurement range is 0 to 14 pH.

This meter is designed to take readings with automatic or manual temperature compensation. Automatic temperature compensation only occurs when a temperature sensor is plugged into the meter. For manual temperature compensation, the default setting is 25°C. It is also possible to manually adjust the temperature to match your working conditions (as measured by a separate thermometer). To take measurements:

1. Remove the pH probe soaker bottle by rotating the bottle and cap and slide the bottle and cap off the probe. Rinse the probe tip with deionized or distilled water before use. If the probe tip is dehydrated, soak it for 30 minutes in a KCl solution. **DO NOT** wipe the pH probe dry. Wiping the probe may cause static and cause calibration and measurement instability.
2. Press **POWER** to turn the meter **on**. ATC appears on the LCD to indicate that the automatic temperature compensation probe is connected and working properly.
3. Immerse the probe tip (glass bulb) completely into the sample.
4. Stir the probe gently to create a uniform sample.
5. Wait until the reading has stabilized. If enabled in setup, "READY" will illuminate to indicate a stable reading.



6. Press **MODE** to switch between mV and pH.

MEASUREMENT PROCEDURES

mV Measurement (± 499 mV)

mV measurement range is from -499 mV to +499 mV with a pH probe.

1. Follow Step 1 in the pH Measurement section (page 30) to clean and soak the probe.
2. Press **POWER** to turn the meter on. Press **MODE** to select mV mode.
3. Follow Steps 3-5 in the pH Measurement section (page 30) to obtain a reading.



4. Press **MODE** to switch between mV and pH.

ORP (mV) Measurement (± 1999 mV)

Oxidation Reduction Potential (ORP) measurement range is -1999 mV to +1999 mV. Use an ORP probe for measurement:

1. Follow Step 1 in the pH Measurement section (page 30) to clean and soak the probe.
2. Press **POWER** to turn the meter on. Press **MODE** to select mV measurement.
3. Follow Steps 3-5 in the pH Measurement section (page 30) to obtain a reading.

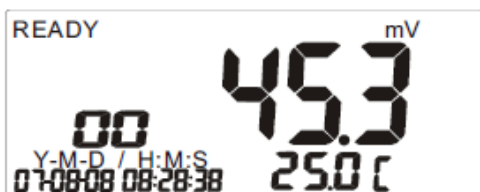

Note...

There is no need to take temperature compensation into consideration when measuring ORP.

MEASUREMENT PROCEDURES

Conductivity Measurement

The conductivity probe measures 0 to 19.99 $\mu\text{S}/\text{cm}$, 0 to 199.9 $\mu\text{S}/\text{cm}$, 0 to 1999 $\mu\text{S}/\text{cm}$, 0 to 19.99 mS/cm , 0 to 199.9 mS/cm . In Normal Mode, the ATC indicator appears in the lower right corner of the LCD to indicate Automatic Temperature Compensation. If you select MTC, the ATC indicator will disappear. When selecting MTC, you must first deactivate ATC in P5.1 (page 18) and then set a MTC value in P5.3 (page 18).

Before measuring, remove the probe cover if needed. To measure:

1. Rinse the probe with de-ionized or distilled water.
2. Press **POWER** to turn the meter on. Press **MODE** to select CON measurement. Before measuring, set the temperature coefficient (P5.4 on page 19).

Note...

Reference temperature or Tref (page 48) of the meter is set at 25°C and CANNOT be adjusted.

3. Immerse the probe tip (glass bulb) completely into the sample.
4. Stir the probe gently to create a uniform sample.
5. Wait until the reading has stabilized. If enabled in setup, “READY” will illuminate to indicate a stable reading.



6. Press **MODE** to switch between CON and TDS/SALT.

MEASUREMENT PROCEDURES

Total Dissolved Solid Measurement

TDS readings display ppm or ppt on the LCD. The ATC indicator appears in the lower right corner of the LCD to indicate Automatic Temperature Compensation. If you select MTC, the ATC indicator will disappear. When selecting MTC, you must first deactivate ATC in P5.1 (page 18) and then set a MTC value in P5.3 (page 18).

Before measuring, remove the probe cover if needed. The conductivity probe measures 0.00 to 9.99 ppm, 0.0 to 99.9 ppm, 0 to 999 ppm. To measure:

1. Rinse the probe with de-ionized or distilled water.
2. Press **POWER** to turn the meter on. Press **MODE** to select TDS measurement. Before measuring, set the temperature coefficient (P5.2 on page 18) and TDS conversion factor (P5.4 on page 19).

Note...

Tref (page 48) of the meter is set at 25°C and CANNOT be adjusted.

3. Immerse the probe tip completely into the sample.
4. Stir the probe gently to create a uniform sample.
5. Wait until the reading has stabilized. If enabled in setup, "READY" will illuminate to indicate a stable reading.

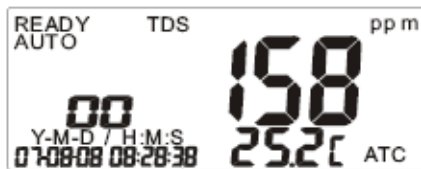

6. Press **MODE** to switch between TDS and CON/SALT.

MEASUREMENT PROCEDURES

Salinity Measurement

Use a conductivity probe to measure salinity range: 0 to 80 ppt (NaCl) with temperature compensations and temperature coefficient settings.

Before measuring, remove the probe cover if needed. To measure:

1. Rinse the probe with de-ionized or distilled water.
2. Press **POWER** to turn the meter on. Press **MODE** to select salinity measurement.
3. Immerse the probe tip completely into the sample.
4. Stir the probe gently to create a uniform sample.
5. Wait until the reading has stabilized. If enabled in setup, "READY" will illuminate to indicate a stable reading.



6. Press **MODE** to switch between SALT and CON/TDS.

Note...

pH and conductivity probes CANNOT be placed in the same container while taking measurements.

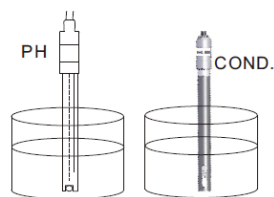
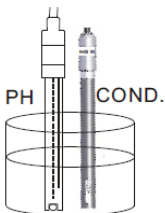

Improper measurement procedure Proper measurement procedure

MEASUREMENT PROCEDURES

Automatic Temperature Compensation

pH Probe

Plug the temperature connector sensor into the ATC port at the rear of the meter.

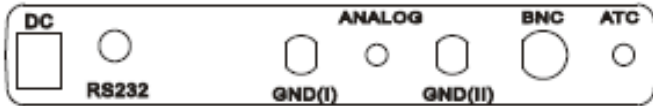





Conductivity Probe

The temperature sensor is built into the conductivity probe. Plug the probe only into the MIC port at the rear of the meter.



Manual Temperature Compensation

pH Probe

1. Disconnect the temperature connector from the rear of the meter.
2. Press MODE to select pH Mode.
3. To set the temperature, press  for more than 1 second. "CAL" will flash on the LCD.
4. Press  or  to change the temperature value. Press  to save and return to Normal Mode.

Conductivity Probe

The temperature sensor is built into the conductivity probe. Follow the manual temperature setting procedures in P5.1 and P5.3 (page18) to set the temperature.

Note...

There is no need to take temperature compensation into consideration when measuring ORP.

MEASUREMENT PROCEDURES

Auto and Manual Range

Press  while in Normal Mode to select automatic or manual range function.

Mode	CON	TDS	SALT
Auto	Full range	Full range	Full range
Range 1	0 to 19.99 uS	0 to 19.99*f ppm	
Range 2	0 to 199.9 uS	0 to 199.9*f ppm	
Range 3	0 to 1999 uS	0 to 1999*f ppm	
Range 4	0 to 19.99 mS	0 to 19.99*f ppt	0 to 11.38 ppt
Range 5	0 to 199.9 mS	0 to 199.9*f ppt	0 to 80.0 ppt

Note...

“f” stands for TDS conversion factor.

Normally, the meter will automatically select a range while taking readings. To select a specific range (or correspondent resolution):



1. While in Normal Mode, press  to select the range setting.



2. If you select automatic range setting, “AUTO” appears on the upper left corner of the LCD.

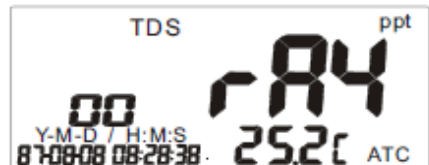

MEASUREMENT PROCEDURES

3. When in manual range mode, E03 will appear on the LCD when the measured value is out of range. Select another range.
4. The meter will return to auto range when it is turned **off**.

Record Memory

The meter can store up to 99 records each of pH, mV, and ORP (mV), conductivity, TDS and salinity readings.

1. In any measurement or Hold Mode, press **MEMO** to save the data.
2. "MEM" will appear on the LCD. The memory number and measured value will flash and the meter will return to Normal Mode.

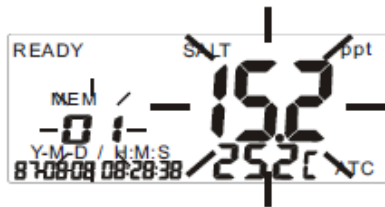

Note...

Further data can not be saved once the memory is full. See Clear Memory (page 12) to create additional space.

Recall Memory

This function recalls readings stored in the memory.

1. Press **REC** for more than 2 seconds to enter Recall Mode. "REC" will flash on the LCD display.

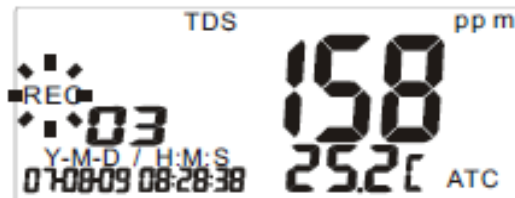

MEASUREMENT PROCEDURES

2. Press ▲ to select the next memory content. Press ▼ to select the previous memory.
3. Press **REC** for more than 2 seconds to exit memory recall and return to Normal Mode.

Note...

All records are retained even when the meter is **off**. To clear records, see page 12.

Recall Maximum & Minimum

This function reviews a maximum and minimum value for all the data points stored in the memory.

1. Press **REC** for 2 seconds to enter Recall Mode. “REC” will flash on the LCD.



2. Press **MN/MX** to view the minimum value of the memory. Press **MN/MX** again to view the maximum value.
3. To exit memory recall, press **REC** for more than 2 seconds and return to Normal Mode.

Note...

All records are retained even when the meter is off. To clear records, see page 12.

MAINTENANCE

pH Probe

It is important to keep the pH probe wet when not in use. The probe is protected by a plastic bottle containing solution. To use or store the probe:

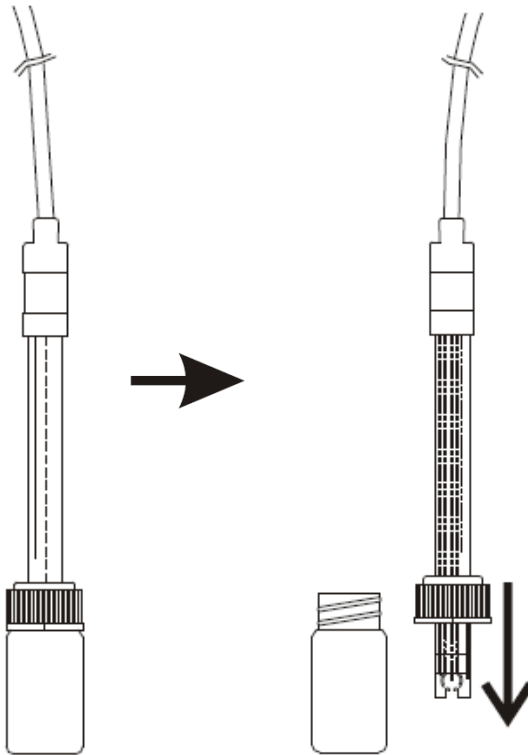

1. Rotate the bottle to remove the bottle from the probe. Pull down the cover and remove it from the probe.
2. After use, put the cover back on the probe and plug the probe into the bottle. Rotate the bottle to fit into the cover tightly.

MAINTENANCE

The following actions will keep the probe in good working condition:

- Always keep the pH glass bulb wet by using the plastic bottle containing the KCl solution to protect and store the probe. Never use distilled or de-ionized water for storage (only to rinse).
- Always rinse the pH probe in de-ionized water before using.
- Never touch or rub the glass bulb tip.

Conductivity Probe

Before using, soak the conductivity probe in distilled water for 30 minutes. We recommend leaving the cover on the probe but you may remove it before calibration and measurement. If removing the cover, the probe must be uncapped in Calibration and Measurement Modes.

- Do NOT touch the surface of the conductivity probe's testing element with hard objects.
- Do NOT use anything to rub the platinum black surface of the probe or the original constants will be changed and the testing range will be affected.
- If the surface of the testing element becomes contaminated, place the probe into diluted detergent or diluted acid for about 15 minutes, then rinse the probe with distilled water.

ORP Probe

Before using, remove the soaking bottle, soak the probe in distilled water, and rinse. **Gently dry the sensing element.**

MAINTENANCE

Probe Testing

1. Connect the ORP probe to the meter via the BNC connector.
2. Put the probe in a buffer solution of pH 7.00 with saturated quinhydrone.
3. Stir; mV reading (E1) should be 86 ± 15 mV.
4. Rinse the probe with distilled water, then set the probe in pH 4.01 buffer solution with saturated quinhydrone. After stabilizing, record the mV meter reading (E2). The difference between E1 and E2 should be 165 mV.
5. Rinse the probe with distilled water between each use. Keep the ORP probe wet. If not in use for long periods, the probe should be rinsed and stored in the soaker bottle filled with the soaking solution.

ORP Probe Cleaning

A contaminated sensing element can result in a slow response and/or inaccurate reading.

If the contamination is mineral matter, put the sensing element in a 0.1 N HCl solution for 10 minutes. Rinse in distilled water.

- If the contamination is oil or grease, clean with a mild detergent. Rinse in distilled water.
- Upon completion of either cleaning method, immerse the probe in a saturated buffer solution with pH 4.01 for 15 minutes and rinse with distilled water. After cleaning, soak the probe in solution for at least 8 hours.

Probe Performance

The sensing element of an ORP probe is made of a high purity metal. Soaking the sensing element in a solution for a long period of time may cause slow response time and inaccurate readings. An oxidation reduction coating may have formed on the surface of the sensing element. Resolve by cleaning the element.

When measuring a solution with a low concentration of oxidation reduction matter and slow ion exchange rate, a slow response time and inaccurate readings may occur. Under these conditions, it may take 8-24 hours to obtain an accurate reading.

TROUBLESHOOTING

Meter does not turn on:

1. Press **POWER** for more than 2 seconds.
2. Check the power adapter connection.

Unstable readings:

1. Stir the solution to make a uniform sample and make sure the sensor is completely immersed in the solution. The measurement must be done while the probe is in the container/solution.
2. Clean and re-calibrate or replace the probe.
3. Move to a new location for measurement, RF emissions from unknown sources may disrupt readings.

Readings not changing:

1. Check to see if the meter is in Hold Mode.
2. Release the "HOLD" function.
3. Check to see if the meter is in "MTC," if so, input the temperature value.

Slow response:

1. Clean and re-calibrate or replace the probe.

Wrong real time:

Incorrect real time display will not affect the measurements. The internal battery needs replacing. Contact Sper Scientific for battery replacement procedures.

ERROR CODES

E02	Reading is under the lower range limit; See page 52 for range specifications for all parameters
E03	Reading is over the upper range limit; See page 52 for range specifications for all parameters
E04	Error in measuring original data (damaged temperature sensor or temperature out of specifications) results in conductivity or pH value error. E02 or E03 will also appear in the temperature column. If E04 is caused by high liquid temperature (E03), cool down the liquid temperature.
E12	Factory calibration data error (pH); Restart the meter
E13	Slope or Offset value of the pH probe is out of range
E16	Factory calibration data error (conductivity); Restart the meter
E17	Cell constant of the conductivity probe is out of range; Restart the meter
E31	Measuring circuit failure; Restart the meter
E32	Memory Integrated Circuit failure

PC CONNECTION

The meter can interface with a personal computer to capture on-line or stored data.

Connection procedures:

1. Plug a USB or RS232 cable into the jack labeled RS232 on the rear side of the meter.
2. Plug the USB connector into a computer. COM ports 1-8 can be used.
3. Insert the CD-Rom into the computer and follow the procedure in the operation manual located on the CD.

Software Download

With technology upgrading, some computers no longer have a disc drive for you to install the software that comes with your meter. You can download the software that came with your meter directly. Go to the **www.sperdirect.com/software.htm** and find your meter or search for you meter (**860030**, **860031**, or **860033**) and download from product page.

Note...

Some software may not be directly available to download due to it must be purchased. If you find that the software you need is not available, please contact our Customer Support at 480.948.4448 or email info@sperscientific.com for further assistance.

1. After installing the **840052 software**, open the **dialogue box** and click **autorun.exe**
2. You can download the complete manual for the software by clicking **Manual**

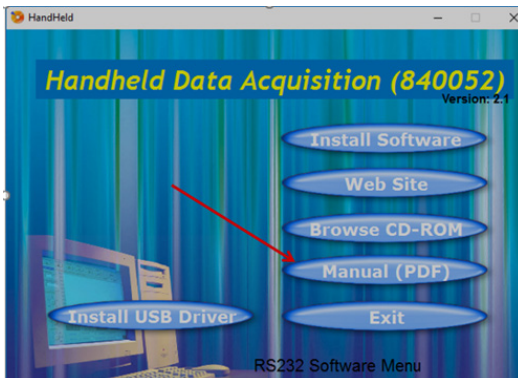

Protocol Information

RS232 protocol settings: 9600 bps, 8 data bits, no parity.
(Transmits ASCII code every second.)

Normal Data:

pxx.xxpH: mxx.xxmV: Cxxxx(xx.xx, xxx.x)mS(uS) : Dxxxx(xx.xx, xxx.x)
ppm(ppt) : Sxx.xxppt:Txxx.xC(F):Txxx.xC(F)
@ 2007-04-18

18:48:48LRCCRLF

Errors:

ExxNul: ExxNul: ExxNul: ExxNul: ExxNul: ExxNul: ExxNul
@ 2007-04-18

18:48:48LRCCRLF

Description:

\$pH:mV:Cond:TDS:Salt:TpH:Tcon LRC CRLF

Note...

The first value is the pH reading in pH, the second value is the Voltage reading in mV, the third value is Conductivity in mS/uS, the fourth value is TDS in ppm/ppt, the fifth value is SALT in ppt, the sixth value is Temperature of the pH probe in °C/°F, the seventh value is Temperature of the conductivity probe in °C/°F. "x" means one of {0|1|2|...|9|-} **PC CONNECTION**

Format in Memory Transmit (pH Mode)

Normal Data:

pxx.xxpH: Txxx.xC(F) #xx @2007-04-18

18:48:48LRCCRLF

Errors:

ExxNul: ExxNul #xx @2007-04-18

18:48:48LRCCRLF

Description:

\$pH: Temp LRC CRLF

Format in Memory Transmit (mV Mode)

Normal Data:

mxx.xxmV: Txxx.xC(F) #xx @2007-04-18

18:48:48LRCCRLF

Errors:

ExxNul: ExxNul #xx @2007-04-18

18:48:48LRCCRLF

Description:

\$mV:Temp LRC CRLF

Format in Memory Transmit (Conductivity Mode)

Normal Data:

Cxxxx(xx.xx, xxx.x)mS(uS) : Txxx.xC(F) #xx @2007-04-18
18:48:48LRCCRLF

Errors:

ExxNul: ExxNul #xx @2007-04-18
18:48:48LRCCRLF

Description:

\$Cond: Temp LRC CRLFPC CONNECTION

Format in Memory Transmit (TDS Mode)

Normal Data:

Dxxxx(xx.xx, xxx.x)ppm(ppt) : Txxx.xC(F) #xx @2007-04-18
18:48:48LRCCRLF

Errors:

ExxNul: ExxNul #xx @2007-04-18
18:48:48LRCCRLF

Description:

\$TDS: Temp LRC CRLF

Format in Memory Transmit (Salt Mode)

Normal Data:

Sxx.x(xx.xx) ppt : Txxx.xC(F) #xx @2007-04-18
18:48:48LRCCRLF

Errors:

ExxNul: ExxNul #xx @2007-04-18
18:48:48LRCCRLF

Description:

\$Salt: Temp LRC CRLF

APPENDICES

APPENDIX A: CONDUCTIVITY to TDS CONVERSION FACTORS

Conductivity at 25°C	TDS KCl		TDS NaCl		TDS 442	
	ppm value	Factor	ppm value	Factor	ppm value	Factor
1413 uS	744.7	0.527	702.1	0.4969	1000	0.7078
2070 uS	1045	0.5048	1041	0.5029	1500	0.7246
2764 uS	1382	0.5	1414.8	0.5119	2062.7	0.7463
8974 uS	5101	0.5685	4487	0.5	7608	0.8478
12,880 uS	7447	0.5782	7230	0.5613	11,367	0.8825
15,000 uS	8759	0.5839	8532	0.5688	13,455	0.897
80 mS	52,168	0.6521	48,384	0.6048	79,688	0.9961

442 stands for:

40% sodium sulfate, 40% sodium bicarbonate and 20% sodium chloride.

APPENDIX B: CALCULATING TDS CONVERSION FACTORS

The meter can be calibrated using TDS calibration standard solutions. The calibration standard requires the TDS value at a standard temperature such as 25°C. To determine the conductivity-to-TDS conversion factor, use the following formula:

Factor=Actual TDS ÷ Actual Conductivity @ 25°C

Definitions:

Actual TDS: Value from the solution bottle label or from a standard buffer, which is made using high purity water and precisely weighted salts.

Actual Conductivity: Value measured using a properly calibrated Conductivity/TDS/Temperature meter.

Both the actual TDS and the actual conductivity values must be in the same magnitude of units. For example, if the TDS value is in ppm, the conductivity value must be in uS; if the TDS value is in ppt, the conductivity value must be in mS. Check this number by multiplying the conductivity reading by the factor in the formula and the result is the TDS in ppm.

APPENDICES

APPENDIX C: TEMPERATURE EFFECT

Conductivity measurements are temperature dependent; if the temperature increases, conductivity increases. For example, the conductivity measured in a 0.01 M KCl solution at 20°C is 1.273 mS/cm, whereas at 25°C, it is 1.409 mS/cm.

The concept of reference temperature (Normalization temperature) was introduced to allow the comparison of conductivity results obtained at different temperatures. The reference temperature is usually 20°C or 25°C. The meter measures the actual conductivity and temperature, then converts it to the reference temperature using a temperature correction function and displays the conductivity at the reference temperature. It is mandatory to associate the temperature together with a conductivity result. If no temperature correction is applied, the conductivity is the value taken at the measurement temperature.

Linear Temperature Correction

In moderately and highly conductive solutions, temperature correction can be based on a linear equation involving a temperature coefficient (θ). The coefficient is usually expressed as a conductivity variation in %/°C. Linear temperature correction is used for saline, acids, and leaching solutions.

$$K_{T_{ref}} = \frac{100}{100 + \theta \cdot (T - T_{ref})} \cdot K_T$$

Where:

$K_{T_{ref}}$ = Conductivity at T_{ref}

K_T = Conductivity at T

(while T_c in P5.2 is set as 0.0, the measured conductivity is K_T)

T_{ref} = Reference temperature

T = Sample temperature

θ = Temperature coefficient

Note...

The correction is accurate only within a limited temperature range around T_1 and T_2 . The greater the difference between T and T_{ref} , the higher the risk of error.

APPENDICES

Calculating Temperature Coefficients (θ)

By measuring the conductivity of a sample at temperature T1 close to Tref and another temperature T2, you can calculate the temperature coefficient by using the following equation:

$$\theta = \frac{(K_{T2} - K_{T1}) \cdot 100}{(T2 - T1) \cdot K_{T1}}$$

T2 should be selected as a typical sample temperature and should be approximately 10°C different from T1. The temperature coefficients of the following electrolytes generally fall into the ranges show below:

Acids: 1.0 - 1.6%/°C

Bases: 1.8 - 2.2%/°C

Salts: 2.2 - 3.0%/°C

Drinking water: 2.0%/°C

Ultra-pure water: 5.2%/°C

Temp. Range °C	KCl 1 M	KCl 0.1 M	KCl 0.01 M	Saturated NaCl
15 - 25	1.725	1.863	1.882	1.981
15 - 25 - 35	1.730 (15 - 27°C)	1.906	1.937 (15 - 34°C)	2.041
25 - 35	1.762 (25 - 27°C)	1.978	1.997 (25 - 34°C)	2.101

Average temperature coefficients of standard electrolyte solutions expressed as %/°C of the conductivity value at 25°C.

APPENDICES

APPENDIX D: TEMPERATURE EFFECT ON NIST pH BUFFERS

	0°C	5°C	10°C	15°C	20°C	25°C
pH 1.68	1.67	1.67	1.67	1.67	1.68	1.68
pH 4.01	4.01	4.01	4.00	4.00	4.00	4.01
pH 6.86	6.98	6.95	6.92	6.90	6.88	6.86
pH 9.18	9.47	9.38	9.32	9.27	9.22	9.18
pH 12.45	13.43	13.21	13.00	12.81	12.63	12.45

	30°C	35°C	40°C	45°C	50°C
pH 1.68	1.69	1.69	1.70	1.70	1.71
pH 4.01	4.01	4.02	4.03	4.04	4.06
pH 6.86	6.85	6.84	6.84	6.83	6.83
pH 9.18	9.14	9.10	9.07	9.04	9.01
pH 12.45	12.29	12.13	11.99	11.84	11.70

OPTIONAL ACCESSORIES

For 860031 (pH/mV)

840016	pH Probe (non-ATC)
840049	Spear Tip pH Probe (non-ATC)
840051	Flat Surface pH Probe
850059P	Replacement ATC pH Probe
850088	ORP Probe
840054	USB Cable
860008	pH4, 3 bottles, 40mL each
860009	pH7, 3 bottles, 40mL each
860010	pH10, 3 bottles, 40mL each
860011	De-ionized Water, 3 bottles, 40mL each
860030H	Bench Top Probe Holder Arm

For 860032 (Conductivity/TDS/Salinity)

850038P	Replacement Conductivity/TDS/Salinity Probe
840054	USB Cable
860030H	Bench Top Probe Holder Arm

For 860033 (Water Quality)

840016	pH Probe (non-ATC)
840049	Spear Tip pH Probe (non-ATC)
840051	Flat Surface pH Probe
850038P	Replacement Conductivity/TDS/Salinity Probe
850059P	Replacement ATC pH Probe
850088	ORP Probe
840054	USB Cable
860008	pH4, 3 bottles, 40mL each
860009	pH7, 3 bottles, 40mL each
860010	pH10, 3 bottles, 40mL each
860011	De-ionized Water, 3 bottles, 40mL each
860030H	Bench Top Probe Holder Arm

SPECIFICATIONS

Unit of Measure	Range	Resolution	Accuracy
pH	0 to 14 pH	0.01 pH	± 0.02 pH
ORP	-1999 to 1999 mV	0.1 mV (-199.9 to 199.9 mV) otherwise 1 mV	± 0.2 mV (-199.9 to 199.9 mv) otherwise ± 2 mV
Conductivity	0 to 19.99 uS 0 to 199.9 uS 0 to 1999 uS 0 to 19.99 mS 0 to 199.9 mS	0.01 uS 0.1 uS 1 uS 0.01 mS 0.1 mS	± (1% FS + digit)
TDS	0 to (19.99*f) ppm 0 to (199.9*f) ppm 0 to (1999*f) ppm 0 to (19.99*f) ppt 0 to (199.9*f) ppt f=TDS conversion factor	0.01 ppm 0.1 ppm 1 ppm 0.01 ppt 0.1 ppt	± (1% FS + digit)
Salt (Based on NaCl)	0 to 11.38 ppt 0 to 80.0 ppt	0.01 ppt 0.1 ppt	± (1% FS + digit)

Unit of Measure	ATC or MTC	Calibration	Calibration Acceptable Window
pH	Yes	Automatic buffer recognition	NIST: ± 1.25 at 6.86 CUSTOM: ± 1.00
Conductivity	Yes	Maximum 5 points (one point per range)	± 20% of the factory default value and ≥ 10% FS
TDS	Yes	Maximum 5 points (one point per range) Adjust TDS conversion factor	± 20% of the factory default value and ≥ 10% FS
Salt (Based on NaCl)	Yes	Maximum 2 points (one point per range)	

SPECIFICATIONS

pH Slope/Offset display	(pH Mode only)
Slope alarm	Out of 75% to 115% (pH)
Offset alarm	Out of ± 60 mV (pH)
Conductivity cell constant	1.0 (Conductivity)
Conductivity Temperature Coefficient (Tc)	0.0% to 10.0%/°C (Conductivity)
Reference temperature (Tref)	Factory set at 25°C (Conductivity)
TDS conversion factor	0.300 to 1.000 (TDS) Non-linear compensation (Salt)
Operating temperature:	5°C to 40°C
Operating RH%:	Up to 95% w/o condensation
Storage Temperature:	-20°C to 60°C
Storage RH%:	Up to 95% w/o condensation
Weight:	18 oz (533 g)
Dimensions:	8½" x 6½" x 2¼" (217 x 168 x 58 mm)

SPECIFICATIONS

Conductivity Default Settings

Program	Function	Default	Display	Note
P1.0 P1.1	Memory transmitting MEM sent by RS232	No default	"tr" "out"	Follow Cond or TDS of Normal Mode
P2.0 P2.1	MEM clear CLR confirm	Always defaults "no"	"CLr" "no" or "yes"	Follow Cond or TDS of Normal Mode
P3.0 P3.1 - 3.5	CAL view Cal solution value	14.13 uS, 141.3 uS, 1413 uS, 14.13 mS, 141.3 mS	"CAL" Cond/ TDS/ SALT solution value	Ra1 to Ra5
P4.0 P4.1 - 4.5	CELL Constant	1.000	"CELL"	Ra1 to Ra5
P5.0 P5.1 P5.2 P5.3 P5.4	Temp setting ATC/MTC Tc M Temp TDS Factor	ATC 2.1% 25°C 0.500	"COEF" "Auto" or "NAn"	0.0% to 10.0% 0.300 to 1.000
P6.0 P6.1	Ready function Enable or disable	"yes"	"rdy" "no" or "yes"	
P7.0 P7.1	Temp unit Select °C or °F	°C	"U" "C" or "F"	
P8.0 P8.1 - 8.6	Real time clock Setting YMD, HMS	No default	"rtc" "rtc"	
P9.0 P9.1	RESET Reset confirm	Always defaults "no"	"rSt" "no" or "yes"	Cond/TDS/ SALT reset

SPECIFICATIONS

pH/mV Default Settings

Program	Function	Default	Display	Note
P1.0 P1.1	Memory transmitting MEM sent by RS232	No default	“tr” “out”	Follow pH or mV of Normal Mode
P2.0 P2.1	MEM clear CLR confirm	Always defaults “no”	“CLR” “no” or “yes”	Follow pH or mV of Normal Mode
P3.0 P3.1 - 3.4 P3.5	Electrode Slope Offset	100.0% 0.0 mV	“ELE” Slope value Offset value	
P4.0 P4.1 - 4.5	Buffer solution Select buffer	“CUST”	“buF” “NIST” or CUST”	
P6.0 P6.1	Ready function Enable or disable	“yes”	“rdy” “no” or “yes”	
P7.0 P7.1	Temp unit Select °C or °F	°C	“U” “C” or “F”	
P8.0 P8.1 - 8.6	Real time clock Setting YMD, HMS	No default	“rtc” “rtc”	
P9.0 P9.1	RESET Reset confirm	Always defaults “no”	“rSt” “no” or “yes”	pH/mV reset

WARRANTY

Sper Scientific warrants this product against defects in materials and workmanship for a period of **five (5) years** from the date of purchase, and agrees to repair or replace any defective unit without charge. If your model has since been discontinued, an equivalent Sper Scientific product will be substituted if available. This warranty does not cover probes, batteries, battery leakage, or damage resulting from accident, tampering, misuse, or abuse of the product. Opening the meter to expose its electronics will break the waterproof seal and void the warranty. To obtain warranty service, ship the unit postage prepaid to:

SPER SCIENTIFIC LTD.
8281 E. Evans Rd., Suite #103
Scottsdale, AZ 85260
(480) 948-4448

The defective unit must be accompanied by a description of the problem and your return address. Register your product online at www.sperwarranty.com within 10 days of purchase.

